

Quick Start Guide

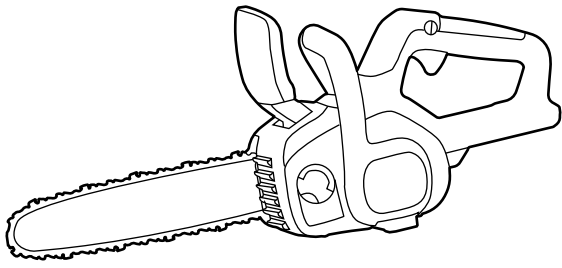

Depending on the model purchased, packaging will contain different accessories and parts. Refer to the 'Color Box' for more details.

OVERVIEW

1

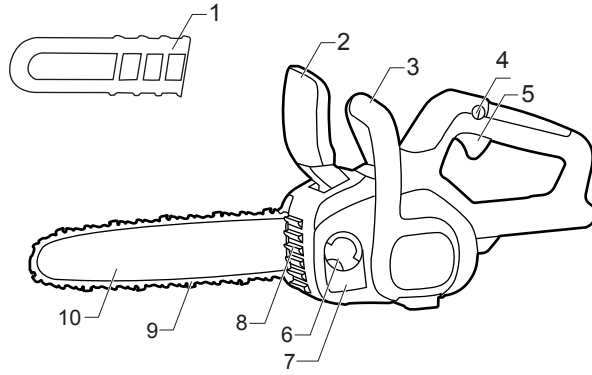

- 1.Scabbard
- 2.Front handle guard / chain brake
- 3.Front handle
- 4.Lock out button
- 5.Trigger
- 6.Oil tank cap
- 7.Oil indicator
- 8.Spike bumpers
- 9.Saw chain
- 10.Guide bar

2

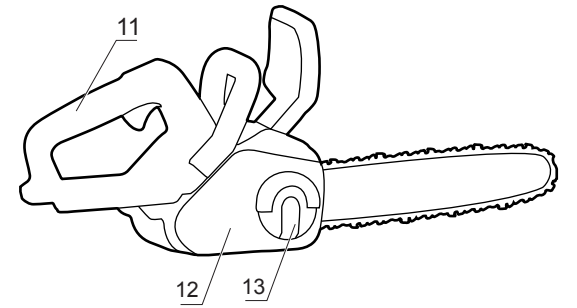

- 11.Rear handle
- 12.Chain cover
- 13.Chain cover knob / Chain tension knob

greenworks



greenworks Europe: www.greenworkstools.eu



greenworks USA: www.greenworkstools.com

P0804316-00 Rev B1

INSTALLATION

3

Add oil

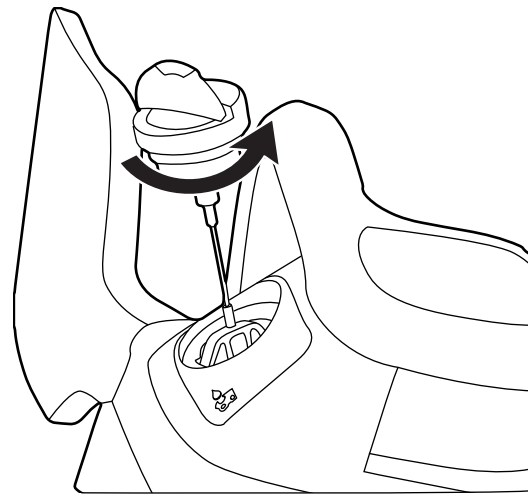

INSTALLATION

4

Assemble the bar and chain

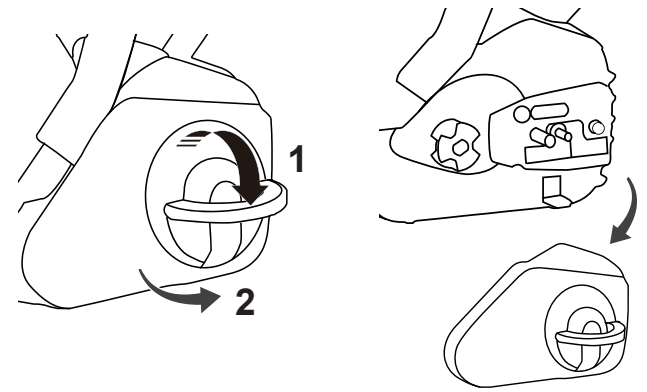

5

Assemble the bar and chain

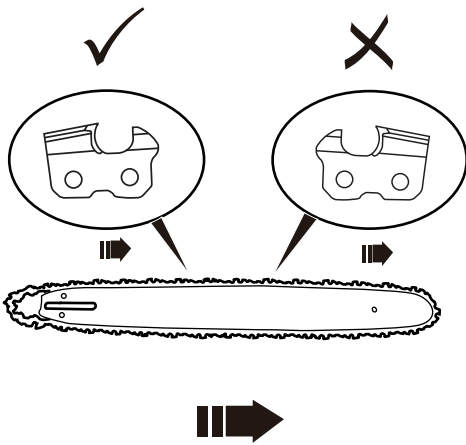

6

Assemble the bar and chain

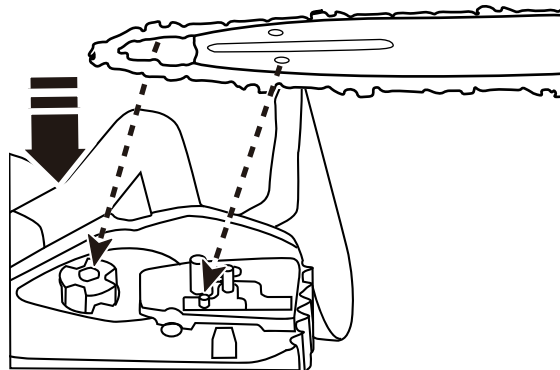

7

Assemble the bar and chain

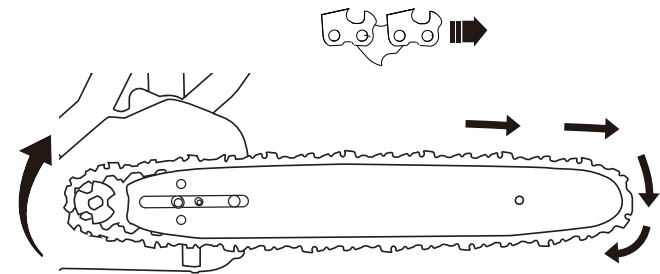

8

Assemble the bar and chain

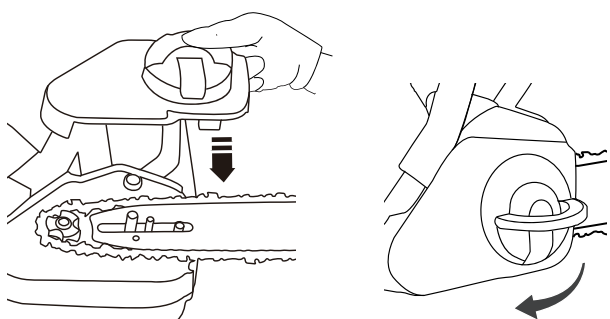

9

INSTALLATION

Install the battery pack

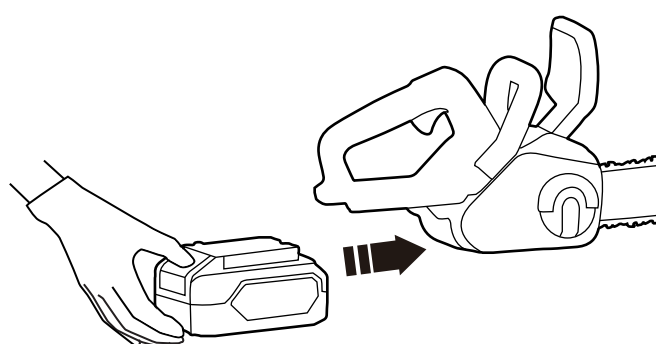

10

OPERATION

Start the machine

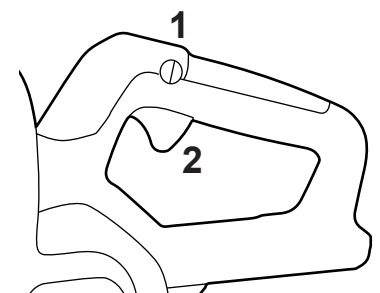

OPERATION

Operate the chain brake

11

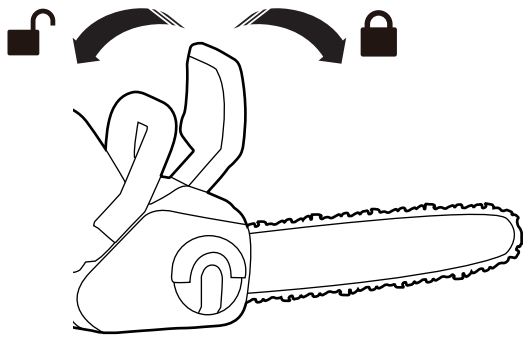

OPERATION

Fell a tree

12

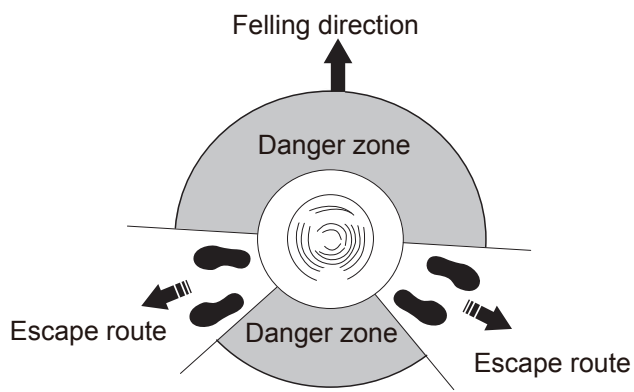

Fell a tree

13

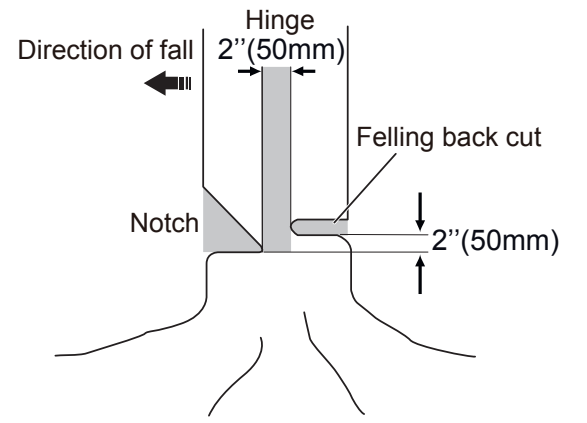

OPERATION

Limb a tree

14

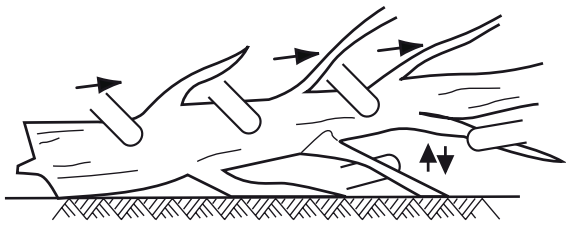

OPERATION

Buck a log

15

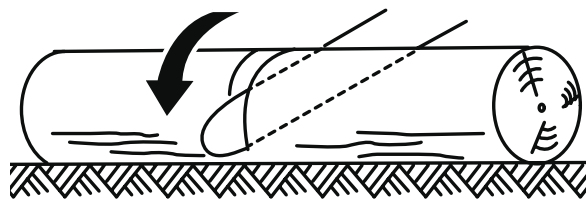

Buck a log

16

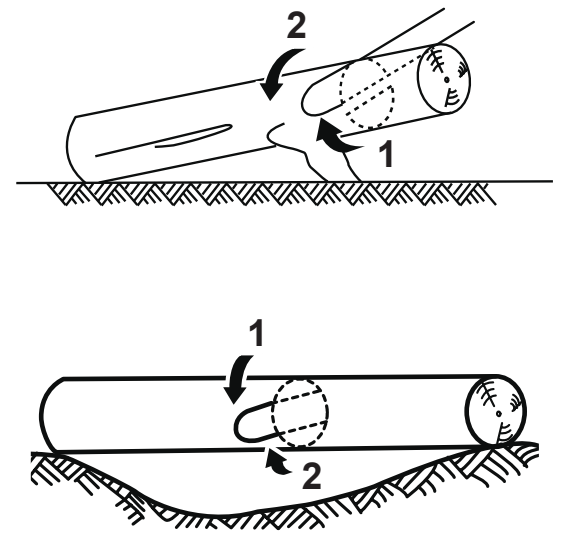

Buck a log

17

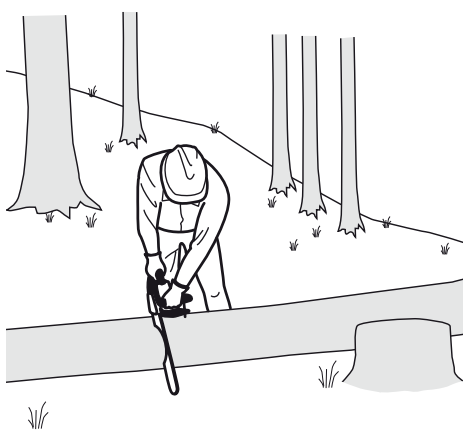

MAINTENANCE

Adjust the chain tension

18

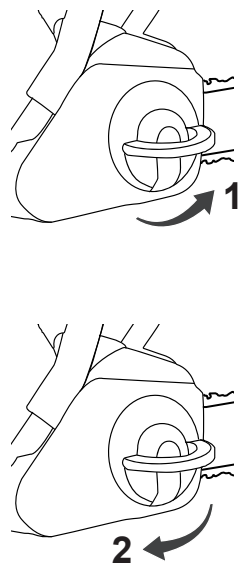

Adjust the chain tension

19

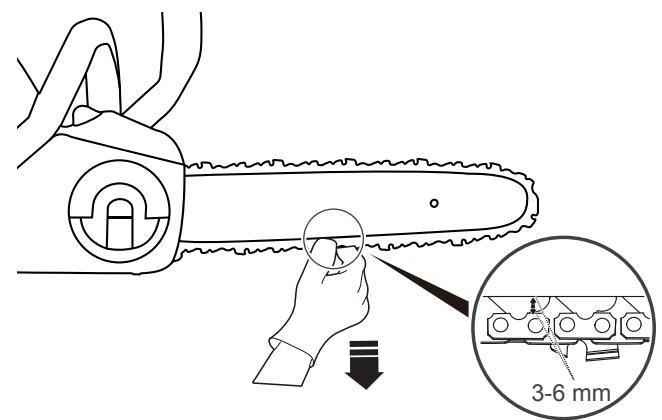

Sharpen the cutters

20

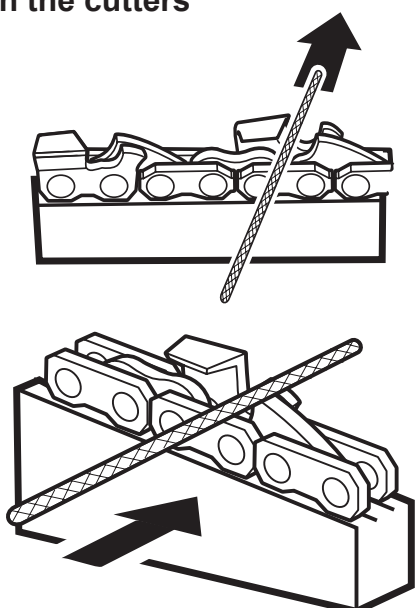

Sharpen the cutters

21

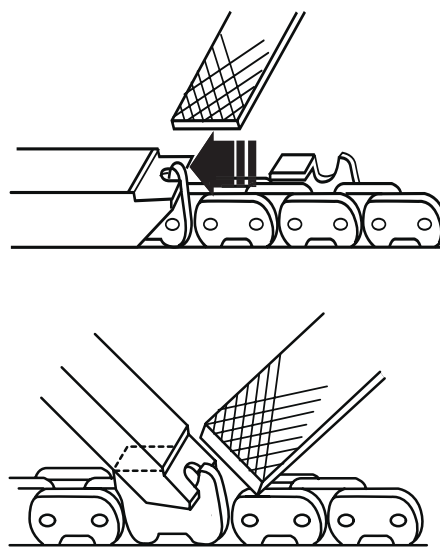

Guide bar maintenance

22

